

ATTENTION注意
OBSERVE PRECAUTIONS
FOR HANDLING
ELECTROSTATIC
DISCHARGE
SENSITIVE
DEVICES
请勿裸手接触器件

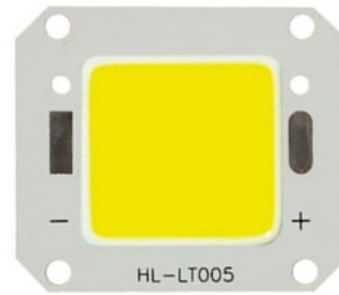

Features 特点

- Dimension 46mm×40mm×2.4mm
尺寸46mm×40mm×2.4mm
- 20W class high-power LED 大功率集成
- CRI: Ra 70 显色指数: 70
- Wide viewing angle : 120°
- 发光角度: 120°
- Lambertian radiation pattern朗伯光照模式
- RoHS compliant (ROHS标准)

Applications应用

- Street lights 路灯
- Floodlight 泛光灯
- Mining lamp 工矿灯
- Tunnel Light 隧道灯

Package Dimensions封装尺寸

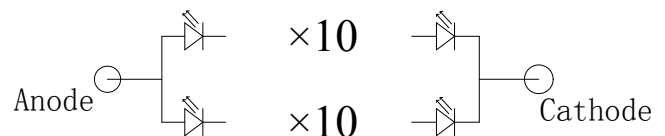
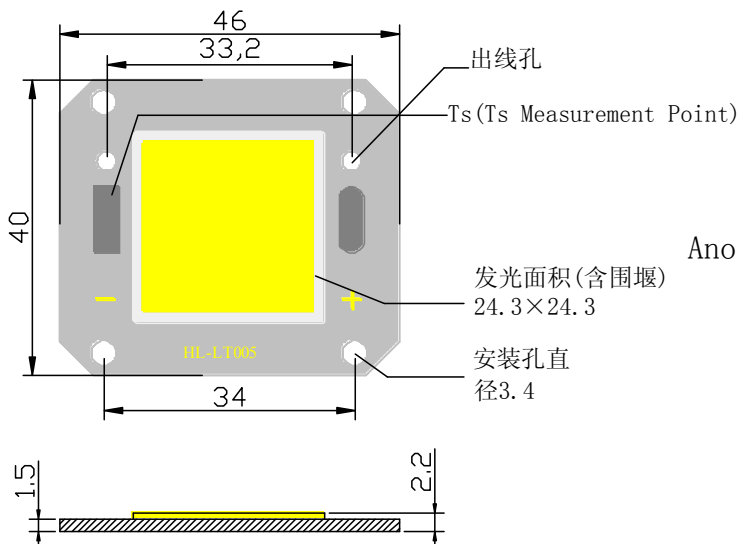

Notes (注意):

1. All dimension units are millimeters.所有尺寸单位为毫米
2. All dimension tolerance is ± 0.2 mm unless otherwise noted.所有尺寸公差为 ± 0.2 毫米除非另有说明
- 3.D.C. Current: $T_j = T_s + R_j \cdot s \cdot X \cdot P_i$



Specifications规范

(1) Absolute Maximum Ratings at Ta=25°C绝对最大额定值在25°C

Parameter参数	Symbol符号	Rating 值	Units单位
Input power 输入功率	Pi	32	W
Maximum operating current 最大工作电流	IF _{max}	1000	mA
Junction Temperature结温	Tj	120	°C
Operating Temperature Range操作温度	Topr	-20°C To +75°C	
Storage Temperature Range储藏温度	Tstg	-40°C To +100°C	
Lead Soldering Temperature*引线焊接温度	T _{SOL}	Max. 350°C for 5sec Max.	

Note (注意):

1.The temperature of Copper PCB do not exceed 75°C.

基板负极引线温度不能超过75°C

2.When hand soldering,keep the temperature of iron below less 350°C less than 5seconds

当手工焊接时,烙铁的温度必须小于350°C,时间不能超过5秒

(2) Optical Characteristics at Ta=25°C IF=700mA

典型的光学特性在Ta 25°C IF=700mA

HL-LT003F38W-40B4C10 (Ra1)					
CCT (K)	Ra	Min (lm)	Typ (lm)	Max (lm)	LM/W (min)
3000	70	1950	2100	—	90
4000	70	1950	2100	—	90
5000	70	2050	2200	—	95
6000	70	2050	2200	—	95

Note:

1.The tolerance of measurement at our tester is Vf+/-3% , Φv+/-10% and Ra+/-2.测试仪测量的公差在电压±3% , 流明±10% 和显指±2

2.All high power LED products mounted on Aluminum substrate can be lighted directly, but we do not recommend lighting the high power products for more than 5 seconds without a appropriate heat dissipation equipment.

所有高功率LED产品必须安装在散热板上点亮, 同时我们不建议在没有一个合适的散热器时, 点亮本产品超过5秒。

(3) Optical Electrical /Thermal Characteristics at Ta=25° IF=700mA

典型的电学/热学特性在Ta=25°C IF=700mA

IF (mA)	VF (V)			R (j-s) (°C/W)	Po (W)
	min	typ	max		
700	30	31.2	34	1.36	22



Under Development	
Mass production	●

Product bins

Chromaticity bins

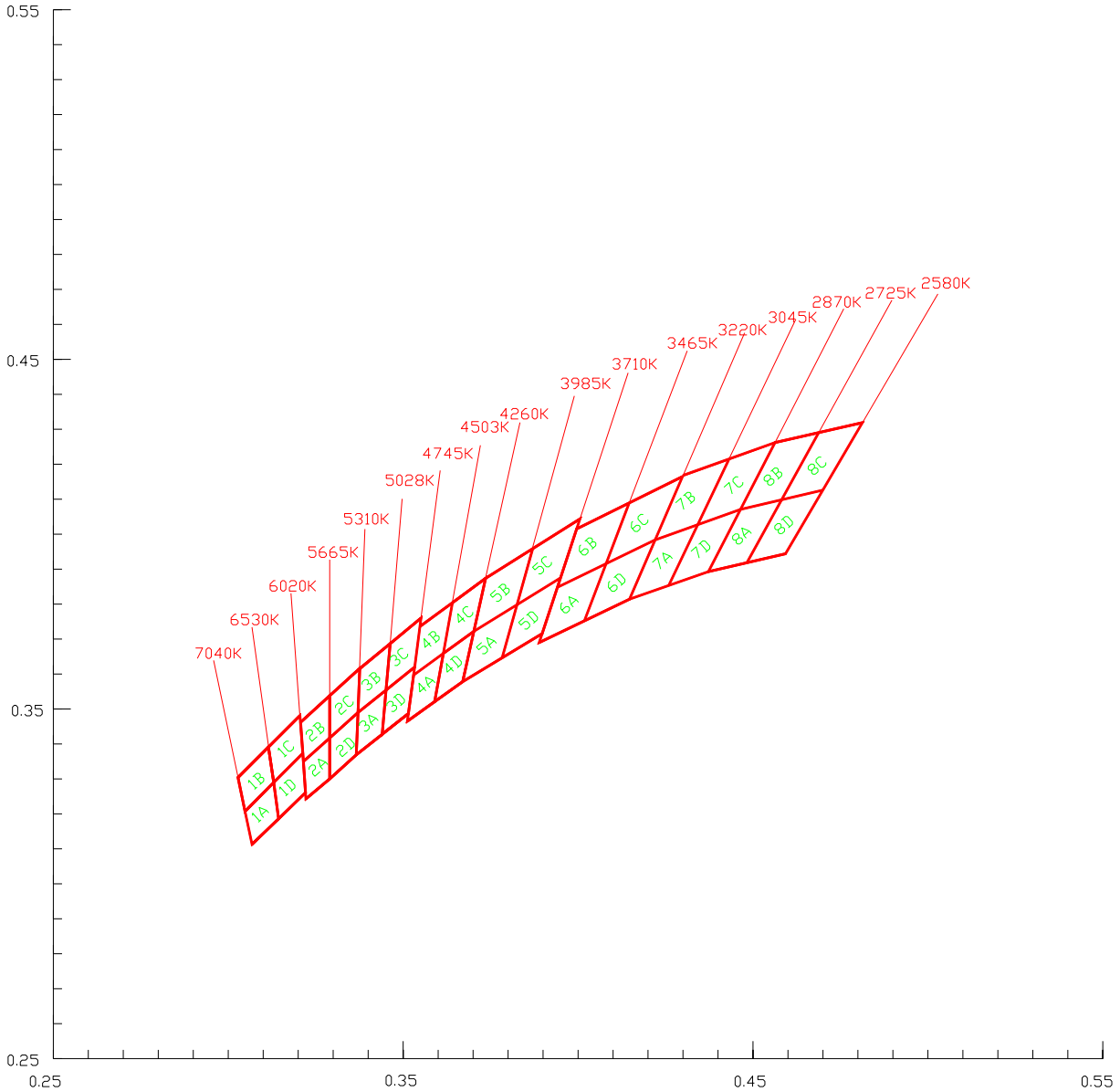

Notes:

- 1. Color coordinates measurement allowance : ± 0.005
色坐标的测量误差允许在 ± 0.005
- 2. Color bins are defined at IF=700mA operation
该产品通过瞬态700mA点亮, 分光分色



Under Development	
Mass production	●

Spatial Distribution Graph 光学特性曲线分布图

Relative Radiant Power - IF
正向电流与相对辐射功率

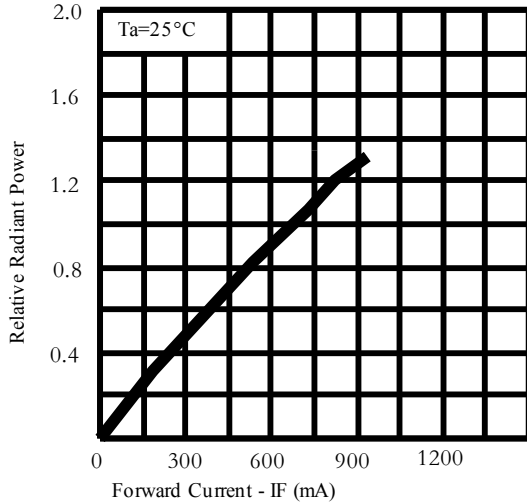

Allowable Forward Current - Ta
环境温度与正向电流曲线图

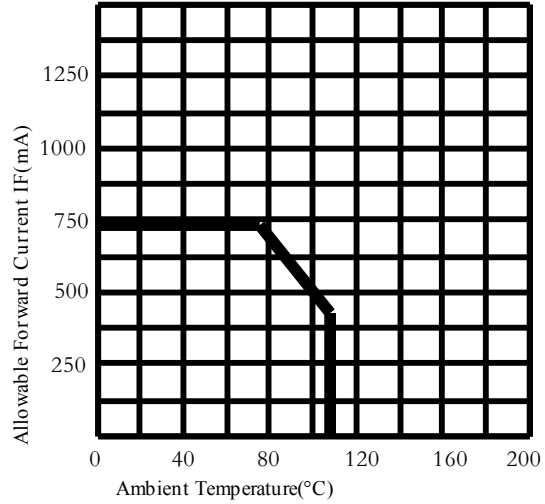

IF - VF
正向电压与正向电流曲线图

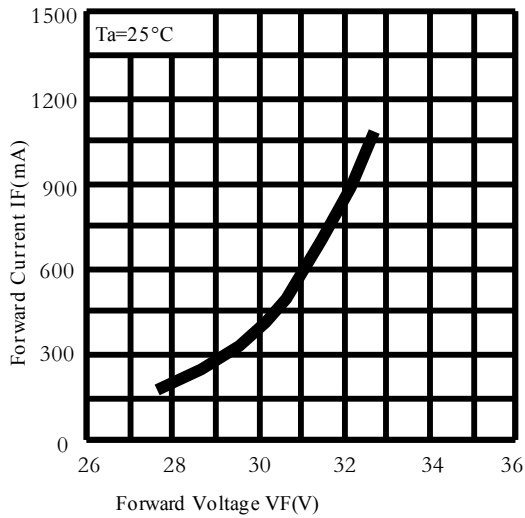

Case Temperature vs. Relative Luminous Intensity

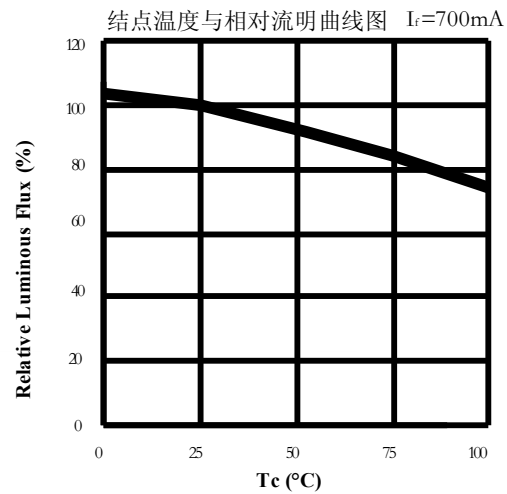

Wavelength Characteristics Ta=25°C
相对光谱分布曲线图

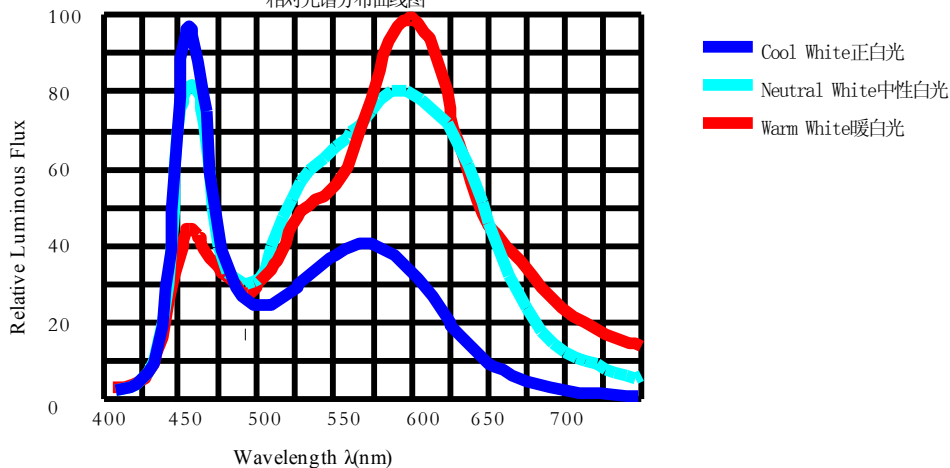



Under Development	
Mass production	●

Radiation diagram 辐射特性曲线图

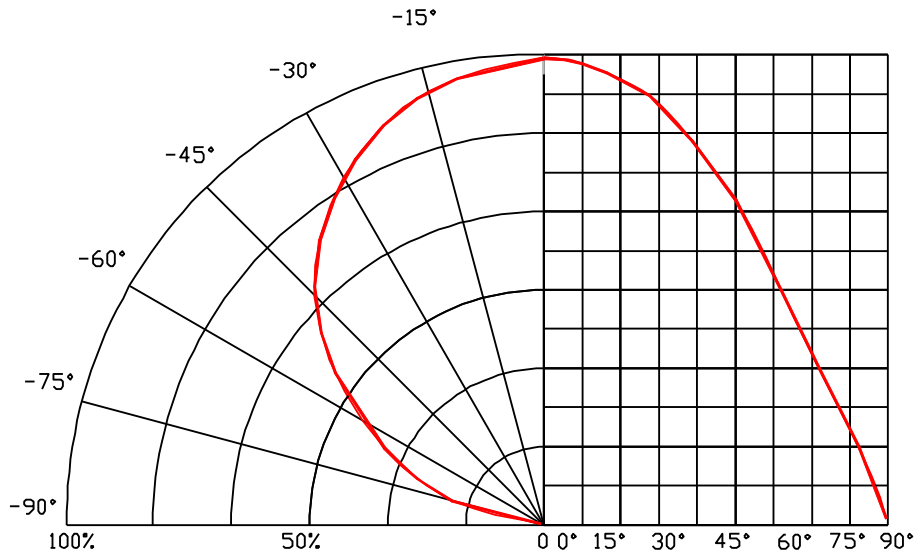

Tape Specification 包装规范

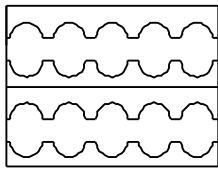

Tray: 10pcs

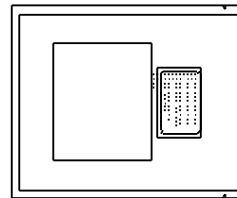
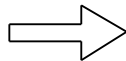

1 Trays/ESD Shielding Bag: 10pcs

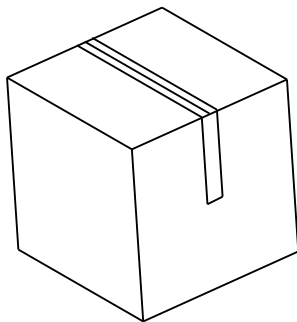

Outer Box

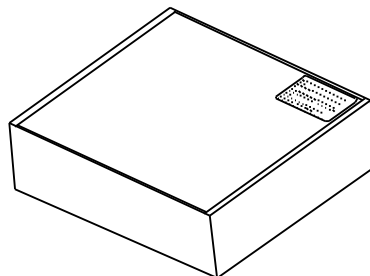
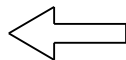

5 ESD Shielding Bags/Inner Box: 50pcs



Under Development	
Mass production	●

Precaution for use (防护措施)

1. Storage 储存

To avoid the moisture penetration, we recommend storing LEDs in a dry box (or a desiccator) with a desiccant. The recommended conditions are temperature 5 to 30 degrees Centigrade. Humidity 60% maximum. 避免湿气的渗透, 我们建议 LED 储存在干燥的盒子里(或干燥器中)并放置干燥剂. 建议的条件是温度 5~30°C, 相对湿度不能超过 60%.

2. Precaution after opening packing 拆包后的注意事项:

2.1. Soldering should be done right after opening the package (within 24Hrs).

拆包后 24 小时内必须焊接完成.

2.2. Keeping of a fraction. 剩余部分

-Sealing 密封.

-Temperature: 5~30°C Humidity: less than 30% 温度: 5~30°C, 相对湿度不能超过 30%

2.3. If the package has been opened than 1 week or the color of desiccant changed, components should be dried for 10-12 Hrs at 60±5°C. 如果开封超过一周或湿度标示卡发生改变, 元件必须在 60±5°C 条件下进行 12 小时除湿.

3. Hand Soldering 手动焊接

Be careful because the damage of the product is often started at the time of the hand soldering.

产品的损害往往是在开始手动焊接时不小心导致的。在开始手动焊接时, 需小心避免对产品造成损害。

Stress on the LEDs should be avoided during heating in soldering process. Please do not force over 1000g impact or pressure diagonally on the silicone lens. It will cause fatal damage on this product.

在焊接加热过程中应避免应力作用在 LED 灯珠上。不要施加超过 1000 克的力于硅胶透镜上, 那样容易对产品造成损伤。

After soldering, do not deal with the product before its temperature drop down to room temperature.

焊接后, 不能将产品迅速冷却至室温。

This product is not adaptable reflow process. 此产品不能过回流焊

4. Cleaning 清洗

It is recommended that alcohol be used as a solvent for cleaning after soldering. Cleaning is to go under 30°C for 3 minutes or 50°C for 30 seconds. When using other solvents, it should be confirmed beforehand whether the solvents will dissolve the package and the silicone or not.

焊接后建议用酒精作为清洗溶剂, 洗清时应 30°C 三分钟或 50°C 持续 30 秒, 当使用其它溶剂时, 应事先确认此溶剂是否会与产品有机硅发生溶解。

Ultrasonic cleaning is also an effective way for cleaning. But the influence of Ultrasonic cleaning on LED depends on factors such as ultrasonic power. Generally, the ultrasonic power should not be higher than 300W. Before cleaning, a pre-test should be done to confirm whether any damage to LEDs will occur.

超声波也是一种有效的清洗方式, 但超声波清洗的程度依赖于诸多因素, 比如超声波功率, 一般来说, 超声波功率不应超过 300W, 在清洗前请确认此清洗方法是否会对 LED 产品造成损害。



Under Development	
Mass production	●

5. Static Electricity 防静电保护

Static electricity or surge voltage damages the LEDs. Damaged LEDs will show some unusual characteristics such as the forward voltage becomes lower, or the LEDs do not light at the low current., even not light. 静电与冲击电压都会损坏LED产品，损坏后的LED灯将产生一系列的不良后果，如正向电压偏低、发光二极管漏电甚至死灯。

All devices, equipment and machinery must be properly grounded. At the same time, it is recommended that wrist bands or anti-electrostatic gloves, anti-electrostatic containers be used when dealing with the LEDs. 所有的设备器材都必须接地保护，同时，建议佩戴静电环或防静电手套，当使用LED灯时应使用防静电容器。

6. Design Consideration 设计考虑

In designing a circuit, the current through each LED must not exceed the absolute maximum rating specified for each LED. In the meanwhile, resistors for protection should be applied, otherwise slight voltage shift will cause big current change, burn out may happen. When the LEDs are illuminating, operating current should be decided after considering the plastic surface maximum temperature.

在设计电路时，电流通过每个LED灯时一定不能超过指定的最大额定值，同时应采用电阻保护，否则电压波动过大将导致涌浪电流，可能会使LED灯烧坏。LED点亮时，需考虑到LED可承受的最大胶面温度。

Viewing direct to the light emitting center of the LEDs, especially those of great Luminous Intensity, will cause great hazard to human eyes. Please be careful.

直接查看发光中的LED灯，特别是发光强度大的，对我们的眼睛会造成非常大的损害。

Thermal Design is paramount importance because heat generation may result in the Characteristics decline, such as brightness decreased, Color changed and so on. Please consider the heat generation of the LEDs when making the system design.

热设计是极为重要的，因为热量的产生可能导致产品性能衰减，如亮度下降、色偏移等。所以在设计LED灯具时，应考虑散热问题。

In the use of screws, you need to pay attention to LED damaged, need to be careful; installation, you can use clip-type to install, to avoid damage!

使用螺丝安装时请注意，方法不当可能导致LED灯的损害，您可以使用卡扣的方式来安装LED灯，以避免损坏LED。

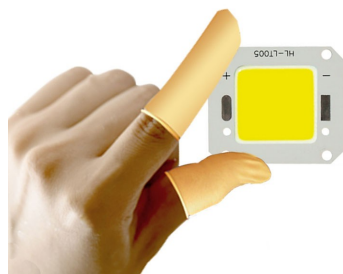

OK

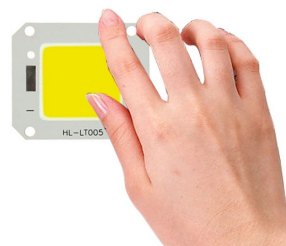

NG