

PRZEKRÓJ
A-A

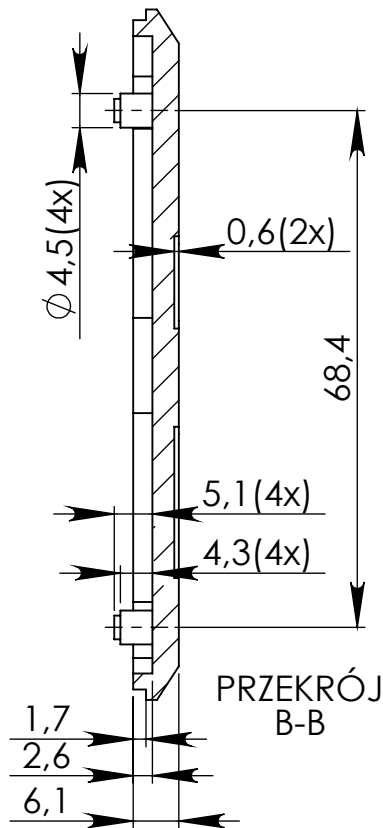
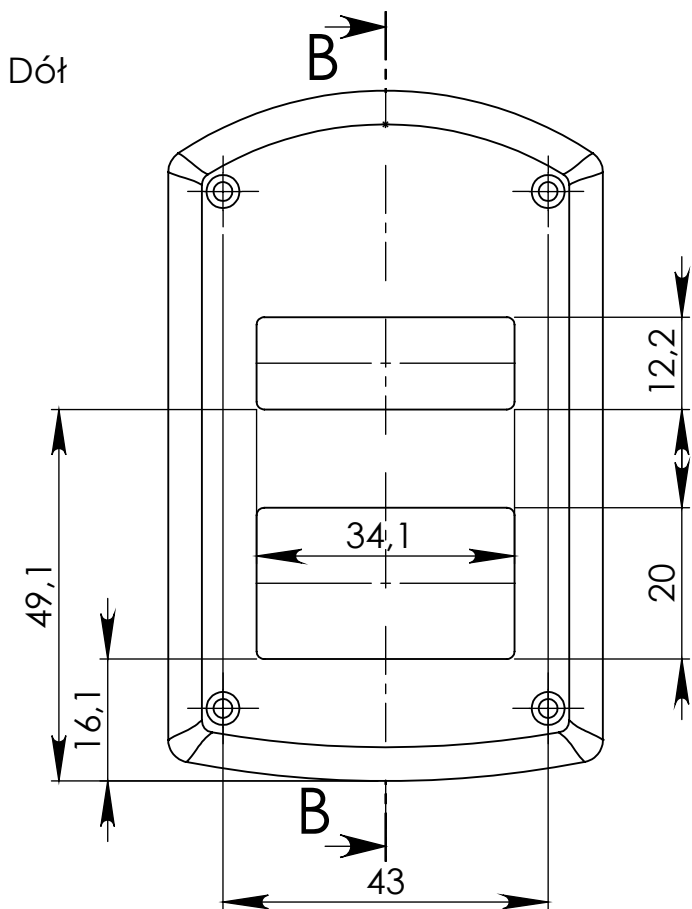

PRZEKRÓJ
B-B

UWAGA: Wymiary w tolerancji $\pm 0,5\text{mm}$

Elementy składowe:
- obudowa góra,
- obudowa dół,
- 4 wkręty,

Format	Skala
A4	1:1
Nr produktu	
KM 100	